



MARITIME THERMAL NIGHT VISION SYSTEMS



CUTTING EDGE THERMAL TECHNOLOGY

WHY THERMAL IS BETTER

THERMAL IMAGING CAMERAS DETECT AND DISPLAY IMAGES BASED ON TINY DIFFERENCES IN HEAT, NOT LIGHT.

NO MATTER HOW MUCH LIGHT IS AVAILABLE—FROM PITCH BLACK TO MOONLIGHT TO SEVERE MIDDAY GLARE—FLIR DETECTORS CAPTURE THE THERMAL ENERGY EMITTED OR REFLECTED BY EVERYTHING, EVEN ICE.

FLIR CAMERAS THEN CONVERT CHANGES IN TEMPERATURE INTO CRISP INFRARED VIDEO IMAGES, ALLOWING YOU TO SEE AT NIGHT AND NAVIGATE IN TOTAL DARKNESS.

OCEAN SCOUT: A HANDHELD THERMAL NIGHT VISION CAMERA – 10

LS-SERIES: HANDHELD THERMAL NIGHT VISION FOR LAW ENFORCEMENT – 12

BHM-SERIES: THERMAL IMAGING HANDHELDS WITH INTERCHANGEABLE LENSES AND BI-OCULAR VISION – 14

MD-SERIES: COMPACT, LIGHTWEIGHT, FIXED-MOUNT THERMAL IMAGER – 16

M-SERIES: PAN AND TILT, SINGLE AND DUAL SENSOR CAMERA SYSTEMS WITH AVAILABLE GYRO-STABILISATION – 18 & 20

M400: HIGH PERFORMANCE, LONG-RANGE, MULTI-SENSOR SYSTEM WITH ADVANCED RADAR AND VIDEO TRACKING OPTIONS – 22

MV/MU-SERIES: SUPER LONG RANGE, MULTI-SENSOR SYSTEMS WITH THERMAL, LOWLIGHT AND COLOUR CAMERA OPTIONS – 24



Nighttime on the Water Made Safer—with FLIR

WHETHER YOU'RE ON THE WATER FOR WORK, FOR PLAY, OR FOR A MISSION, FLIR MARITIME THERMAL IMAGING SYSTEMS TURN NIGHT INTO DAY, KEEPING YOU SAFE, SECURE AND UNDERWAY WITH CONFIDENCE.

From the smallest runabouts to the largest ocean-going vessels, FLIR Maritime offers cutting-edge solutions that are rugged, reliable and simple to use.



How FLIR Helps Protect You

- **Safety and Security** – Thermal imaging works night and day, in total darkness or bright sunlight, through smoke, dust, and even light fog to keep your passengers and crew safe from hazards and threats.
- **Collision Avoidance** – See natural and man-made hazards, such as floating debris, rocks, ice, land, bridge abutments, and other vessels.
- **Finding People Overboard** – Thermal night vision helps you find a person in the water faster than any other night vision technology.
- **Easy to Use** – FLIR cameras and thermal video are incredibly intuitive and easy to understand. Quite simply, what you see is what you get.

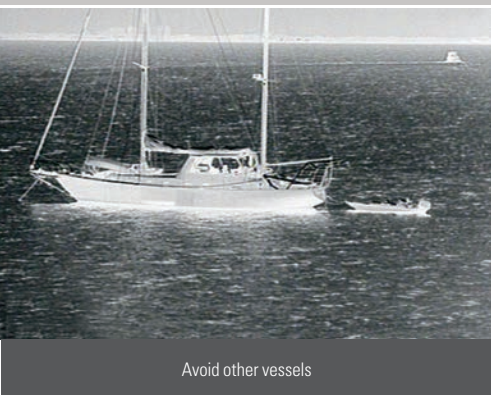
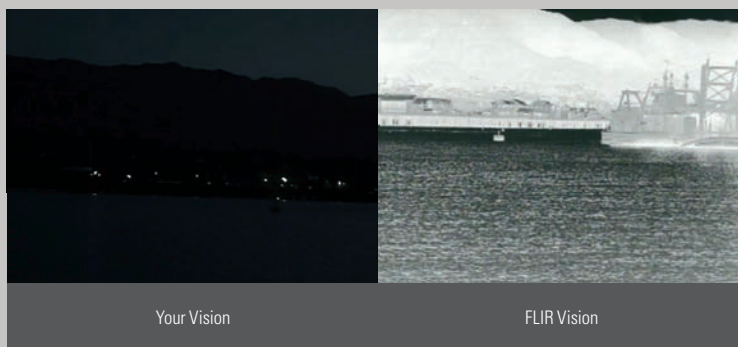

Avoid other vessels



Find people overboard faster

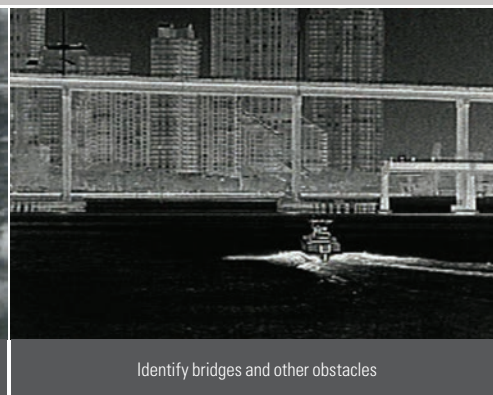

Identify bridges and other obstacles



FLIR for Recreational Boating

BOATING OFFERS A UNIQUE SENSE OF FREEDOM AND INDEPENDENCE. DON'T LET DARKNESS LIMIT YOUR PURSUIT OF ADVENTURE AND PERSONAL ESCAPE FROM EVERYDAY STRESSES.

Professional mariners and militaries around the world have been utilising FLIR thermal night vision for years. Now this same technology is accessible to every boater, from the wheelhouse to the palm of your hand.

Whether you enjoy fishing, cruising, sailing, or just exploring your world, boaters have the same basic goals in mind: enjoy the ride and bring everyone home safe.

RECOMMENDED SYSTEMS:



Ocean Scout Handhelds – pg 10



MD-Series – pg 16



M-Series – pgs 18 & 20



Case Study:

Seeing in Total Darkness in a Maritime Environment

Practically all boaters associate their time on the water with holidays and fun, but it can be a dangerous place, especially at night or in bad weather.

Collisions, groundings, and man overboard scenarios result in heavy damage and sometimes loss of life.

Thermal cameras are very effective at detecting these hazards and helping boaters to identify and avoid them.

Read the full case study online at www.flir.com/nightnavigation

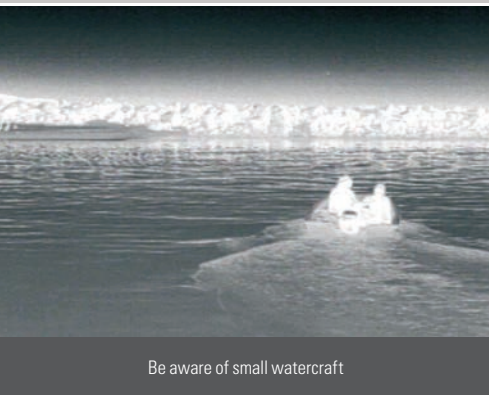

Be aware of small watercraft



Improve dock safety

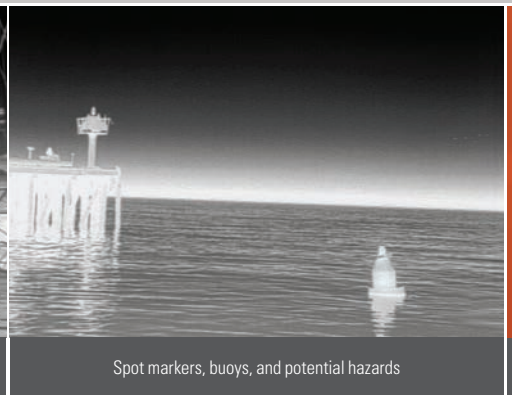

Spot markers, buoys, and potential hazards



FLIR for Commercial Mariners

THE SEA CAN BE A DANGEROUS PLACE, ESPECIALLY AT NIGHT OR IN BAD WEATHER.

But professional mariners can't call it a day when the weather turns foul. FLIR thermal imagers offer an "early warning system" against common hazards so mariners can sail with confidence, whatever the conditions.

FLIR maritime thermal imagers display the invisible heat energy from a myriad of potential hazards, including floating debris, shipping lane traffic, vessels riding at anchor, and small boats. FLIR imagers can also reveal man-made structures, such as buoys, bridge abutments, docks and piers. They can even spot icebergs and surfacing whales.

RECOMMENDED SYSTEMS:



M-Series – pgs 18 & 20



M400 – pg 22



MV/MU-Series – pg 24



Case Study:

Navigating Oil Tankers Through Icy Waters with FLIR Thermal Imaging

Shipping companies are more and more concerned about the safety of ice-class tankers during sub-zero operation and are looking for equipment that can help detect arctic ice at great enough distances to avoid collisions.

Based on recommendations by the Oil Companies International Maritime Forum (OCIMF), the Greek company TMS Tankers installed FLIR M-Series thermal imaging cameras on two oil tankers that operate in arctic waters.

Read more about FLIR ice navigation at www.flir.com/icenavigation



Monitor crew on deck



Track potentially threatening vessels



Locate icebergs



FLIR for First Responders

MARITIME FIRST RESPONDERS FACE A GROWING RANGE OF ROLES AND RESPONSIBILITIES

Police boats, fireboats, harbour patrol vessels, and fish and game vessels pursue diverse missions, including search and rescue, SCUBA operations, port security, disabled boat assistance, and HAZMAT emergencies. Day and night, in good and bad weather, public safety vessels utilise the broad range of features that FLIR thermal imaging cameras offer for critical mission success.

RECOMMENDED SYSTEMS:



LS-Series Handhelds – pg 12



BHM-Series Handhelds – pg 14



M-Series – pgs 18 & 20



M400 – pg 22

Case Study:

Norwegian Search and Rescue

FOR THE NORWEGIAN SOCIETY FOR SEA RESCUE (NSSR), SEEING IN THE DARK QUITE LITERALLY MAKES THE DIFFERENCE BETWEEN LIFE AND DEATH.

In the winter months, the northern parts of Norway are enveloped in darkness for all but a few hours each day. This would normally reduce the effectiveness of the NSSR crews in emergency situations. However, with FLIR cameras installed, darkness no longer limits the NSSR crews.

“Every search and rescue society should equip their vessels with FLIR cameras,” says search and rescue inspector, Ronny Pedersen. “I am absolutely certain that these cameras will save human lives. It’s really just a matter of time.”

Read more about FLIR thermal imaging for Search and Rescue at www.flir.com/searchandrescue



See suspects in the dark



Gain situational awareness when approaching vessels

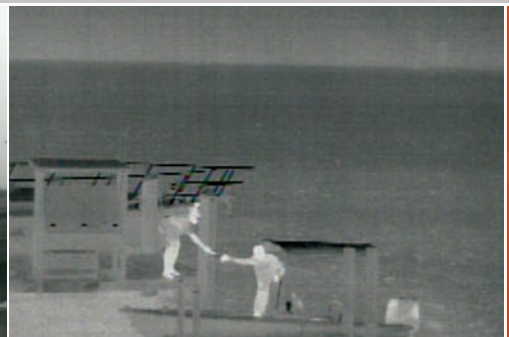

Observe late night activity on shore

Ocean Scout Handhelds

Ocean Scout is a rugged, compact thermal night vision camera that reveals other vessels, landmarks, buoys, and floating debris in total darkness.

Now with a high resolution LCD display and FLIR's industry-leading sensor technology, Ocean Scout makes your time on the water even safer and more relaxing.

ENHANCED AWARENESS

See marine traffic and navigational aids at night

- Quickly scan your surroundings for other vessels
- Easily recognise buoys in river channels or open water
- Detect key landmarks like islands or docks

STEER CLEAR

Navigate with confidence day or night

- Avoid obstacles, such as exposed rocks, floating logs, ice, and other debris
- Be aware of kayakers, personal watercraft, and small boats without lights
- Detect marine mammals above the water surface

STAY SAFE

A lifesaving tool for a "man overboard" emergency

- Locate the body heat of anyone in the water
- Quickly recognise people and pets overboard
- InstAlert™ mode highlights the hottest objects in red



Ocean Scout 240



Ocean Scout 320

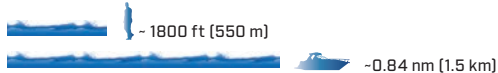

Ocean Scout 640



OCEAN SCOUT	OCEAN SCOUT 240	OCEAN SCOUT 320	OCEAN SCOUT 640
Detector Resolution	240 x 180	336 x 256	640 x 512
Refresh Rate		9 Hz	
Field of View	24° x 18°	17° x 13°	18° x 14°
Zoom	NA	2X e-Zoom	2x, 4x, and e-zoom
Colour Palettes	White Hot / Black Hot / InstAlert™		
Battery	Internal Lithium Ion rechargeable (5-hour typical life)		
Waterproofing	IP-67 Submersible to 1 Metre		
Weight	12 oz (340 g)		
RANGE PERFORMANCE			
Person in the Water	1,150 ft (350 m)	1,800 ft (550 m)	3,705ft (1.14 km)
Small Vessel	0.48 nm (0.90 km)	0.84 nm (1.5 km)	1.73 nm (3.2km)
FOR COMPLETE PRODUCT SPECIFICATIONS, PLEASE VISIT WWW.FLIR.COM/MARITIME			



See other boaters



Find people overboard faster with InstAlert™



Use Ocean Scout off the water in the outdoors and around the home

LS-Series Tactical Thermal Night Vision*

FLIR's LS-X and LS-XR handheld thermal night vision monoculars are built specifically for those who serve and protect. As a proven force-multiplier, the LS-Series helps maritime first responders see clearly at night while conducting search and rescue missions, patrolling ports and harbours, assisting disabled boaters, and even responding to HAZMAT emergencies.

The new LS-X and the LS-XR feature enhanced resolution displays, extended zoom capabilities, a tactical marking laser, and video output.

NEW AND IMPROVED

- Enhanced high-resolution LCD display
- Video output capability
- Up to 8× magnification

SIMPLE OPERATION

- Starts up in seconds
- Multiple InstAlert™ levels call attention to hot objects
- Intuitive menu navigation
- Red Laser pointer

PORTABLE AND RUGGED

- Fits in packs, pockets or included Molle bag
- Rubberised armor protection from accidental drops
- Waterproof, all-weather construction



LS-X



LS-XR

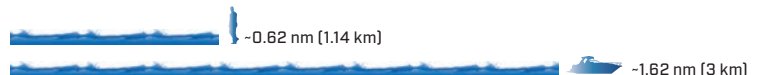

* LS-Series imagers are only available for sale to authorized military, law-enforcement, and first-responder customers.

LS-SERIES**LS-X****LS-XR**

Detector Resolution	336 x 256	640 x 512
Field of View	17° x 13°	18° x 14°
Zoom	2x & 4x e-Zoom	2x, 4x, & 8x e-Zoom
Colour Palettes	White Hot / Black Hot / InstAlert™	
Battery	Internal Lithium Ion rechargeable, (5-hour typical life)	
Laser Pointer	Red Laser Pointer	
Video Output	NTSC or PAL composite via supplied cable	
Waterproofing	IP-67 Submersible to 1 metre	
Weight	12 oz (340 g)	

RANGE PERFORMANCE

Person in the Water	1870 ft (570 m)	0.62 nm (1.14 km)
Small Vessel	0.84 nm (1.55 km)	1.62 nm (3 km)

FOR COMPLETE PRODUCT SPECIFICATIONS, PLEASE VISIT WWW.FLIR.COM/MARITIME



Monitor port activities



Investigate suspicious behavior



Find oil slicks and other toxic spills

BHM-Series Bi-Ocular Thermal Handhelds

BHM-Series cameras are the most powerful handheld thermal night vision camera for search and rescue operations on the water. With interchangeable 35, 65, and 100 mm lenses, the BHM-Series handhelds can detect a small vessel at a distance of more than five nautical miles (up to 8.8 km). The bi-ocular design lets you use both eyes, and features a full-coverage eyepiece, interocular adjustment, and ergonomic comfort—a must for extended use. The BHM-Series also captures still images and video using an onboard SD card.



FLIR HM-Series combine powerful optics along with still image and video recording options. Learn more at: www.flir.com/hmseries

SIMPLE OPERATION

- Intuitive menu options
- Fast power & battery swap
- Multiple InstAlert™ levels call attention to hot objects
- Record stills and NTSC / PAL video to SD card

LONG RANGE DETECTION

- Up to 640 x 480 thermal resolution
- Interchangeable 35/65/100 mm lenses
- FLIR's proprietary Digital Detail Enhancement
- Detect small vessels up to distance of 5.5 miles (8.8 km)

PORTABLE AND RUGGED

- IP-67, submersible
- Camera body withstands 1 m drop
- Ergonomic comfort

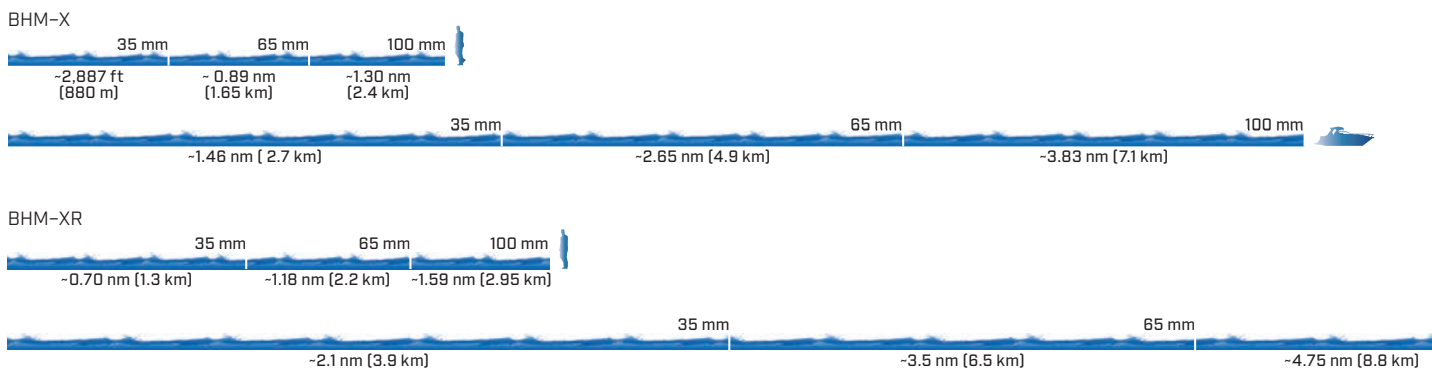

BHM-SERIES	BHM-X+	BHM-XR+
Detector Resolution	320 x 240	640 x 480
Field of View		
35 mm lens	13° x 10°	18° x 13°
65 mm lens	7° x 5°	10° x 8°
100 mm lens	5° x 3°	6° x 4°
Zoom	2× e-Zoom	2× and 4× e-Zoom
Colour Palettes	White Hot / Black Hot / InstAlert™; Selectable	
Battery	4 AA Batteries, NiMH Li-Ion or Alkaline	
Video Output	NTSC or PAL composite via supplied cable	
Waterproofing	IP-67 Submersible to 1 Meter	
Weight		
with 35 mm lens		0.84 lbs (0.38 kg)
with 65 mm lens		3.05 lbs (1.38 kg)
with 100 mm lens		3.06 lbs (1.39 kg)

RANGE PERFORMANCE		
Person in the Water		
35 mm lens	2,887 ft (880 m)	0.70 nm (1.3 km)
65 mm lens	0.89 nm (1.65 km)	1.18 nm (2.2 km)
100 mm lens	1.30 nm (2.4 km)	1.59 nm (2.95 km)
Small Vessel		
35 mm lens	1.46 nm (2.7 km)	2.1 nm (3.9 km)
65 mm lens	2.65 nm (4.9 km)	3.5 nm (6.5 km)
100 mm lens	3.83 nm (7.1 km)	4.75 nm (8.8 km)

FOR COMPLETE PRODUCT SPECIFICATIONS, PLEASE VISIT WWW.FLIR.COM/MARITIME



BHM-X with 35 mm lens



BHM-X with 65 mm lens



BHM-X with 100 mm lens

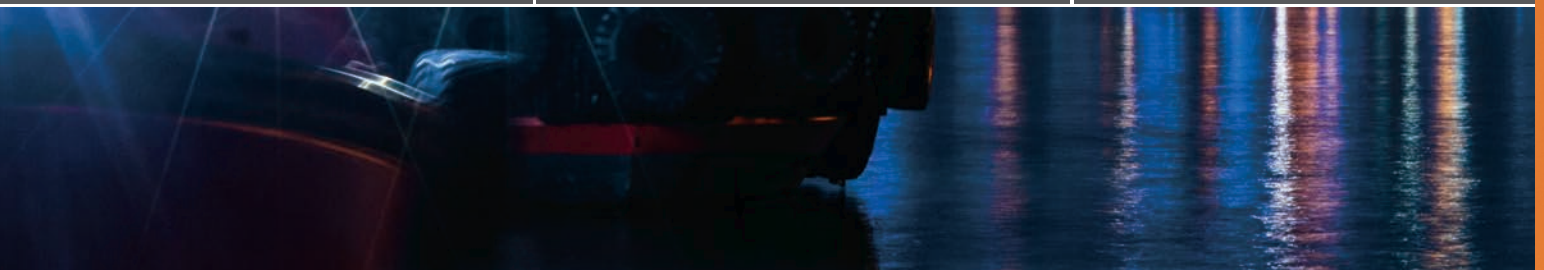

100 mm

MD-Series Fixed Mount Thermal Imager

This affordable, fixed-mount thermal night vision system helps you steer around obstacles, avoid collisions, and find people in the water, day or night. The MD camera body is simple to mount and easy to integrate into existing electronics. Mount the display separately on your dashboard, or view the video feed using existing multifunction navigation displays from leading manufacturers, including Garmin, Furuno, Raymarine and Simrad.

HIGH RESOLUTION THERMAL IMAGING

- Available in 320 x 240 / 640 x 480 resolutions
- 2x e-Zoom standard; 4x e-Zoom (MD-625)
- FLIR Digital Detail Enhancement
- Detects small vessels up to 1.2 nm away

COMPACT, UNOBTRUSIVE MOUNTING

- Only 7" high and weighs 1.36kg (3lbs).
- All-weather, waterproof enclosure
- Ball-up or ball-down mounting options

INTEGRATES WITH EXISTING ELECTRONICS

- Ethernet-enabled, connects to most popular MFDs
- Optional control using iOS device via onboard Wi-Fi network



MD-324

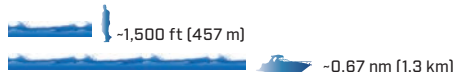

MD-625

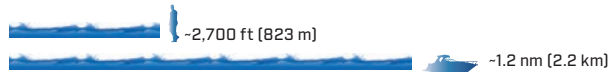

MD-SERIES	MD-324	MD-625
Detector Type	320 × 240 VOx Microbolometer	640 × 480 VOx Microbolometer
Video Refresh Rate	<9 Hz or 30 Hz (NTSC and PAL)	
Field of View	24° × 18° (NTSC)	25° × 20° (NTSC)
Focal Length	19 mm	25 mm
E-Zoom	2×	2×, 4×
Image Processing	FLIR Proprietary Digital Detail Enhancement	
SYSTEM SPECIFICATIONS		
Pan/Tilt Adjustment Range	Pan: ±30° per key, Tilt: +34°, -27° (Locked in at Installation)	
Video Output	NTSC or PAL, 30 Hz or <9 Hz	
Connector Types	F-type BNC with BNC-to-RCA adapter included for video out	
Power Requirements	PoE injector required per IEEE 802.3af, 12-24 VDC	
Power Consumption	4.8 W nominal; 12.5 W max	
ENVIRONMENTAL		
Operating Temperature Range	-13°F to +131°F (-25°C to +55°C)	
Storage Temperature Range	-40°F to +185°F (-40°C to +85°C)	
Automatic Window Defrost	Standard at Power-Up	
Sand/Dust	Mil-Std-810E	
Water Ingress	IP x 6 (heavy seas, powerful jets of water)	
Shock	15 g vertical, 9 g horizontal	
Vibration	IEC 60945; MIL-STD-810E	
Lightning Protection	Standard	
Salt Mist	IEC60945	
Wind	100 knot (115.2 mph)	
EMI	IEC 60945	
PHYSICAL		
Weight	~ 3 lbs (1.36kg)	
Size	6" (152.4mm) dia. × 7" (177.8mm) ht.	
RANGE PERFORMANCE		
Detect Man	1,500 ft (457 m)	2,700 ft (823 m)
Detect Small Vessel	4,200 ft (1280 m)	1.2 nm (2.2 km)

FOR COMPLETE PRODUCT SPECIFICATIONS, PLEASE VISIT WWW.FLIR.COM/MARITIME



Easily see navigation aids masked by bright urban background lighting



Spot crossing traffic, obstacles and hazards



Stay alert to unlit watercraft, kayaks and paddle-boarders

M-Series Pan and Tilt Systems

The M-Series pan/tilt re-defines maritime multi-sensor system design, drawing on FLIR's 25 years of experience in building combat-proven airborne and maritime thermal imagers for militaries, coast guards, and governmental agencies around the world.

With up to 640 x 480 thermal imaging, M-Series cameras let you see more – and see farther – than ever before. Even in the dead of night.

STEER CLEAR OF DANGER

Advanced features improve situational awareness

- Detects other vessels, small crafts, floating objects, and hazards—day or night—through darkness, glare, dust and light fog.
- Display on any marine monitor, or integrate M-Series thermal imaging right on your marine multifunction display alongside charting and radar.
- Simple joystick control of pan, tilt and zoom. Optional advanced touchscreen control from select marine multifunction displays.

SIMPLE TO INSTALL

Integrates seamlessly with existing electronics

- Integrates seamlessly with select multifunction displays from Furuno, Garmin, Raymarine and Simrad.
- Slew-to-Cue target tracking from compatible radar, AIS and chart systems.
- Composite video output for easy connection to MFDs and monitors.

WEATHERPROOF, CONTROLLABLE PAN AND TILT SYSTEM

Engineered especially for harsh marine environments

- Colour symbology on-screen gives instant access to system status, position, and configuration.
- 360° Continuous Pan, +/-90° Tilt with joystick control.



Automatic window heaters keep optics free of ice

2x and 4x e-Zoom functions

Ethernet control link for easy networking to FLIR joysticks or multifunction displays

Standard video signal displays on any monitor with an auxiliary video input



Compatible with multifunction navigation displays from Raymarine, Garmin, Furuno and Simrad

M-324L & M-324XP

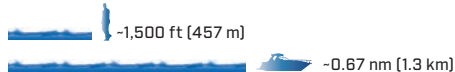

M-625L & M-625XP

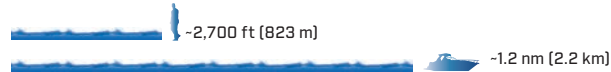

M-612L

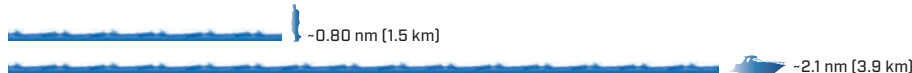

M-SERIES	M-Series 324XP	M-Series 625XP	M-Series 324L	M-Series 625L	M-Series 612L
Detector Type	320 × 240 VOx Microbolometer	640 × 480 VOx Microbolometer	320 × 240 VOx Microbolometer	640 × 480 VOx Microbolometer	
Video Refresh Rate	<9 Hz or 30 Hz (NTSC and PAL)				
Field of View	24° × 18°	25° × 20°	24° × 18°	25° × 20°	12° × 10°
Focal Length	19 mm	25 mm	19 mm	25 mm	50 mm
E-Zoom	2×	2× & 4×	2×	2× & 4×	
Image Processing	FLIR Proprietary Digital Detail Enhancement				
BLACK & WHITE LOWLIGHT CAMERA					
Detector Type	N/A		1/2" Interline Transfer Lowligh CCD		
Lines of Resolution	N/A		768 (H) x 494 (V)		
Minimum Illumination	N/A		100 μlux (@ f/1.4)		
Field of View	N/A		Matched to IR		
SYSTEM SPECIFICATIONS					
Pan/Tilt Coverage	360° Continuous Pan, +/-90° Tilt				
Video Output	NTSC or PAL				
Water Proofing	IP x6 (heavy seas, powerful jets of water)				
PHYSICAL					
Size	7" (177.8mm) dia. × 11.2" (284.4mm) ht.				7" (177.8mm) dia. × 11.2" (284.4mm) ht.
Weight	~ 9 lbs (4kg)				~ 9 lbs (4kg)
RANGE PERFORMANCE					
Detect Man (1.8 m x 0.5 m)	1,500 ft (457 m)	2,700 ft (823 m)	1,500 ft (457 m)	2,700 ft (823 m)	4,900 ft (1494 m)
Detect Small Vessel (2.3 m x 2.3 m)	4,200 ft (1280 m)	1.2 nm (2.2 km)	4,200 ft (1280 m)	1.2 nm (2.2 km)	2.1 nm (3.9 km)

FOR COMPLETE PRODUCT SPECIFICATIONS, PLEASE VISIT WWW.FLIR.COM/MARITIME



See river traffic without being blinded by sun glare



Maneuver through docks at night



Remain aware of landmarks

M-Series with Gyro-Stabilisation

The M-618CS is the most advanced member of FLIR's industry-leading M-Series line of thermal night vision systems. Combining long-range thermal night vision with a colour zoom camera and gyro-stabilisation, the M-618CS is the most capable system in its class.

The M-618CS features a high resolution 640 x 480 thermal imager with 2x and 4x e-Zoom, and extended range performance from its 35 mm thermal lens. The M-618CS can detect small vessels at ranges over 2 miles. Active gyro-stabilisation provides steady imagery in rough seas, critical to getting the most from the system's advanced, long-range optics.

The system's second payload is a colour daylight TV camera with a 10x optical zoom, and low-light capability too. Continuous zoom can match the thermal camera's e-Zoom for easy operation when switching between cameras.



M-618CS

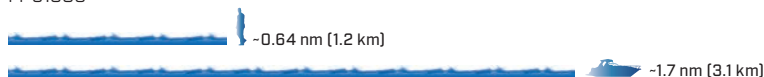

M-SERIES

M-Series 618CS

Detector Type	640 × 480 VOx Microbolometer
Video Refresh Rate	<9 Hz or 30 Hz (NTSC and PAL)
Field of View	18° × 14°
Focal Length	35 mm
E-zoom	2 & 4x
Image Processing	FLIR Proprietary Digital Detail Enhancement

VISIBLE COLOUR CAMERA

Detector Type	Colour CCD
Lines of Resolution	530
Minimum Illumination	1.4 lux
Field of View	~58° (h) x 43° (V) w/10x optical zoom matched to IR, 36x overall

SYSTEM SPECIFICATIONS

Pan/Tilt Coverage	360° Continuous Pan, +/-90° Tilt
Video Output	NTSC or PAL
Water Proofing	IPx6 (heavy seas, powerful jets of water)

PHYSICAL

Size	7" (177.8mm) dia. × 11.2" (284.4mm) ht.
Weight	5.2 kg (~ 11.5 lbs)

RANGE PERFORMANCE

Detect Man	0.64 nm (1.2 km)
Detect Small Vessel	1.7 nm (3.1 km)

FOR COMPLETE PRODUCT SPECIFICATIONS, PLEASE VISIT
WWW.FLIR.COM/MARITIME

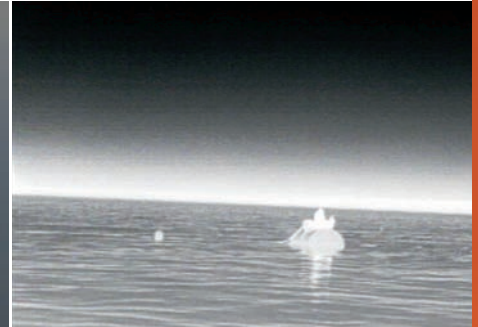

Detect floating debris



Gyro-stabilisation for clear viewing in rough conditions



Colour daylight camera with 36x zoom and low light mode

M400 Multi-Sensor Camera System

The M400's advanced 640 x 480 sensor delivers crisp thermal video images in total darkness and lowlight conditions. An integrated HD colour visible camera and tight-beam LED spotlight augment target identification for added safety. M400 has a continuous optical thermal zoom lens (up to 3x) that allows operators to see other vessels and targets at longer ranges. Active gyro-stabilization ensures a steady image, plus radar tracking and optional video tracking keep potentially dangerous targets in view at all times.

SHORT AND LONG-RANGE DETECTION

Recognise marine traffic and key landmarks at night

- Continuous variable zoom allows you to easily identify vessels or navigation aids at distance
- Quickly recognise nearby buoys in channels or open water
- Detect key landmarks, such as islands or docks

THERMAL AND VISIBLE-LIGHT PAYLOADS

Combination thermal detection and visible identification

- Up to 3x optical thermal zoom for 18° to 6° HFOV
- HD Colour 30x Zoom provides 64° to 2.3° HFOV
- Illuminate and identify nearby targets with powerful LED beam

ENHANCED TARGET IDENTIFICATION

Operators can precisely locate and track objects

- Gyro-stabilisation creates smooth video in rough water
- Radar integration lets the M400 follow specific radar targets
- Step up to video tracking with the M400XR and automatically follow objects in the camera's view
- Intuitive, easy-to-use joystick for effortless operation



High intensity LED spot light

HD Colour lowlight camera with 30x optical zoom

Gyro stabilised to ensure steady viewing in heavy sea conditions

High resolution 640 x 480 thermal sensor, optical zoom 18° to 6° horizontal field of view

Rugged, waterproof gimbal enclosure with 360° pan and +/-90° tilt capability

M400-Series

 -1.3 nm [2.45 km]

 -3.2 nm [6.0 km]

M400 -SERIES**M400****M400XR**

Detector Type	640 x 480 Vox Microbolometer
Field of View	18° to 6° HFOV / 1.5° HFOV with e-zoom
Focal Length	35 mm (Wide) to 105 mm (Narrow)
E-Zoom	1× to 4×
Imaging Processing	FLIR DDE

DAYLIGHT IMAGING SPECIFICATIONS

Detector Type	Long-range colour daylight and low light viewing
Resolution	High Definition up to 1080/30p
Minimum Illumination	>0.5 lux at 50 IRE / .05 Lux in ICR Mode (B/W)
Zoom	30× Optical Zoom
Focal Length	129 mm to 4.3 mm
Field of View	64° to 2.3° Optical HFOV / 0.2 NFOV e-zoom

SPOTLIGHT SPECIFICATIONS

Type, Lumens, Beam°	LED, 580 Lumens, 5° Divergence Angle
---------------------	--------------------------------------

SYSTEM SPECIFICATIONS

Video Tracking	No	Yes
Pan/Tilt Coverage	360° Continuous Pan, +/-90° Tilt	

Video Output	Dual, independent H.264 Network Video Streams, HD-SDI Lossless Digital Video Interface, High Definition Serial Data Interface, Broadcast-quality video output, Provides HD video over coax cable, Switchable Composite Analog Video Output (SD) NTSC or PAL
--------------	---

Camera Head Size	15.18" (385.5 mm) × 18.68" (474.4 mm) / 15.5" (393.7 mm) × 22" (558.8 mm) Swept Volume Cylinder
------------------	--

Weight	20.4kg (45 lbs)
--------	-----------------

Connector Types	BNC, 24V DC
-----------------	-------------

Power Consumption	<50 W Nominal; 130 W Peak, 270 W 2/Heaters
-------------------	--

DETECTION RANGE

Man-sized Target	1.3 nm (2.45 km)
------------------	------------------

Small Vessel-sized Target	3.2 nm (6.0 km)
---------------------------	-----------------

FOR COMPLETE PRODUCT SPECIFICATIONS, PLEASE
VISIT WWW.FLIR.COM/MARITIME



18° to 6° Thermal Horizontal Field of View



Available video tracking automatically keeps targets of interest in view



Continuous optical zoom and gyro-stabilisation for superior long range performance



MU and MV-Series Multi-Sensor Systems

The MU and MV-Series multi-sensor, gyro-stabilised systems give you unparalleled range performance and high definition imaging flexibility. Available with either a cooled infrared detector for extra long-range performance and image detail (MU-Series), or an uncooled infrared detector for stellar thermal imagery to the horizon (MV-Series), both systems come with a high resolution colour camera, and an optional lowlight TV camera.

SAFER NAVIGATION, ALL DAY & ALL NIGHT

Spot other marine traffic, hazards to navigation, and people in the water any time

- Other vessels, debris on the water, rocks, and people in the water stand out day and night
- Navigate more safely and with more confidence than ever
- Make entering harbours at night stress-free

FLEXIBLE THERMAL NIGHT VISION & TV CAMERAS

Combines thermal detection and optional visual identification

- Choice of cooled or uncooled thermal imagers with up to 14x optical zoom
- Standard high resolution colour visible camera and optional lowlight visible camera
- Radar tracking, video tracking, and picture-in-picture display modes for ultimate versatility

EASY INSTALLATION, EASY OPERATION

Simplified operation means you'll get the most from your camera

- Intuitive, easy-to-use joystick for effortless operation
- Flexible integration in ball-up or ball-down orientation
- Ethernet connections make MU-/MV-Series simple to install and integrate



MV [Uncooled]

-2.3 nm [4.3 km]

MU [Cooled]

MU-602CLW

MV-604C

MV-604CL

MAIN THERMAL CAMERA

Detector Type	Focal Plane Array (FPA), Cooled MWIR 640 x 512 pixels	Focal Plane Array (FPA), Uncooled LWIR 640 x 480 pixels
Field of View	Continuous Optical Zoom WFOV 28° x 22.4° to NFOV 2° x 1.6° (PAL)	Continuous Optical Zoom WFOV 24.5° x 18.5° to NFOV 4.1° x 3.1° (PAL)
Focus	Focus free at infinity/Manual/Auto/Wide	

VISIBLE COLOUR CAMERA

Lines of Resolution	550 TV Lines	
Minimum Illumination	0.25 Lux	
Field of View	~56° to 2° (H) 28x optical zoom	

LOWLIGHT B/W CAMERA

Lines of Resolution	570 TV Lines	570 TV Lines
Minimum Illumination	0.0002 Lux (front plate)	0.0002 Lux (front plate)
Focus	Manual/AF	Manual/AF
Field of View	25° to 2.5° (H) 10x optical zoom	25° to 2.5° (H) 10x optical zoom

THERMAL LW CAMERA

Detector Type	Focal Plane Array (FPA), uncooled microbolometer 640 x 480 pixels	N/A	N/A
Field of View	32° (athermalized)		
Digital Zoom	Continuous up to 4x		

DETECTION RANGE

Man-sized Target	4.9 nm (9.0 km)	2.3 nm (4.3 km)
Small Vessel-sized Target	8.3 nm (15.4 km)	4.6 nm (8.6 km)

FOR COMPLETE PRODUCT SPECIFICATIONS, PLEASE VISIT WWW.FLIR.COM/MARITIME



1,500 ft to 1.7 nm range performance



MU's cooled camera increases detail

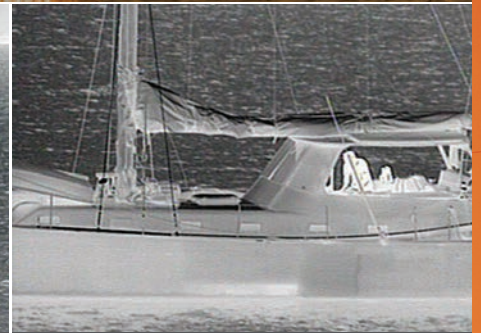

Up to 14X continuous optical zoom

~4.6 nm (8.6 km)

~4.9 nm (9.0 km)

~8.3 nm (15.4 km)

Thermal Imaging Basics

Your Vision/FLIR Vision

Daylight cameras, image intensified night vision (I²), and the human eye all create images from reflected light. I² night vision and similar technologies take in small amounts of visible light and magnify it. However, I² imagers have the same limitations as the human eye: if there isn't enough light available, they don't work well. Plus, during daylight and twilight hours they aren't useful either because there is too much light for them to work effectively.

FLIR thermal cameras work both day and night, regardless of light. They're totally immune to the effects of darkness, glare, or even direct sunlight.

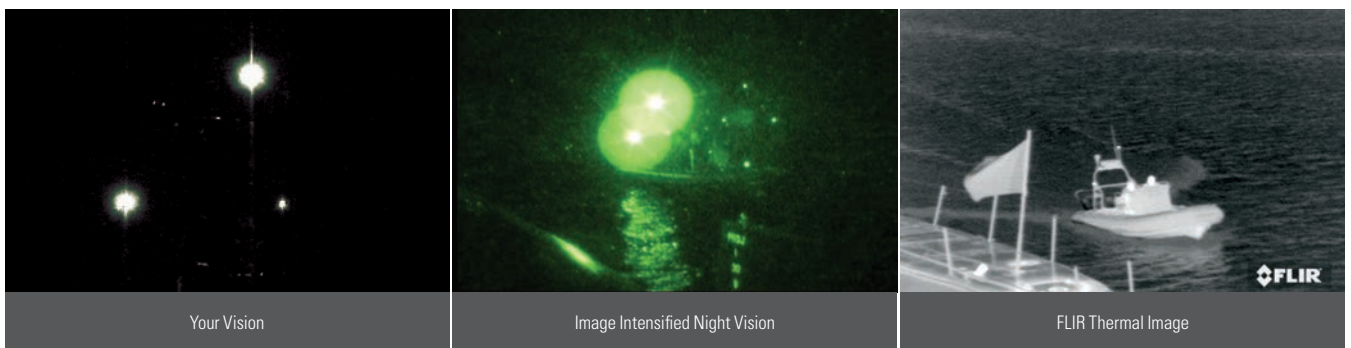

Resolution, Detail and Range

FLIR offers a range of thermal imaging cameras with varying levels of image resolution. Much like a digital camera, FLIR cameras with higher pixel counts offer more detail, clarity and range than models with less resolution. FLIR also offers models with advanced optics for extreme long-range performance.

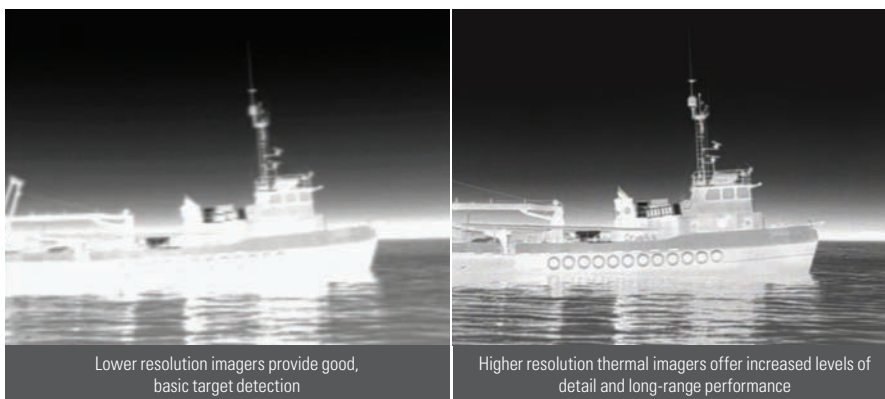

Dimensions

OCEAN SCOUT & LS-SERIES

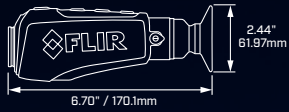

BHM-XSERIES W/ 65 MM LENS

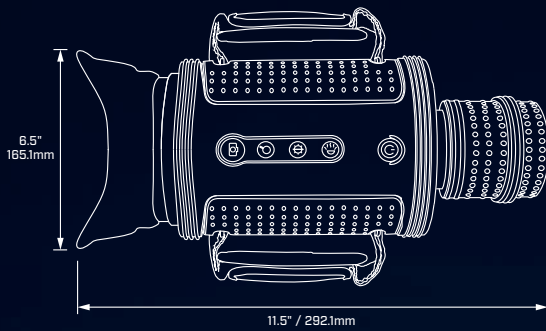

M-SERIES

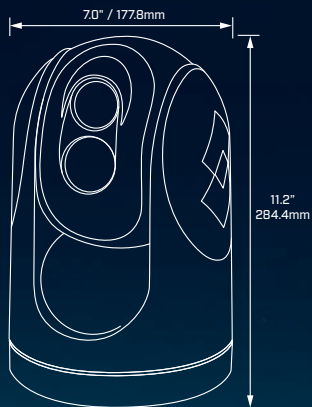

MD-SERIES

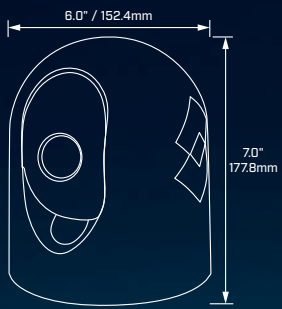

M400-SERIES

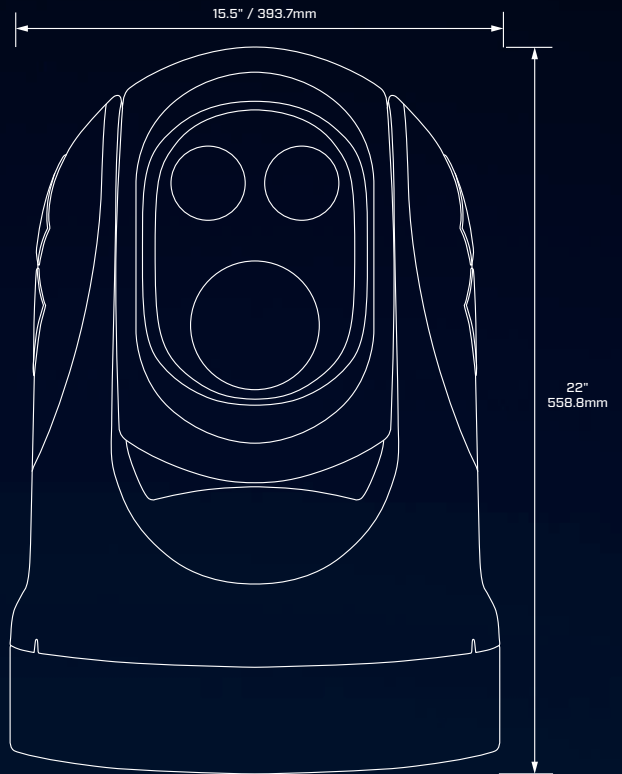

MU/MV

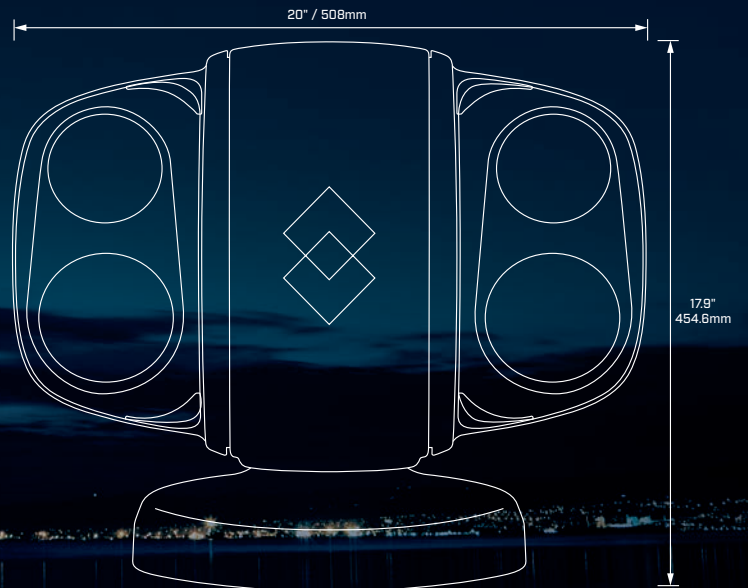

MD, M SERIES JOYSTICK CONTROL UNIT



MV/MU/M400 JOYSTICK CONTROL UNIT



Warranty

FLIR's service commitment of outstanding warranty and technical support now offers you even more; by registering your system with FLIR at www.flir.com/productreg, the 2-Year Standard Limited Warranty is upgraded and replaced by the 3-Year Extended Limited Warranty for FREE.

MU-Series cooled thermal cameras are warranted for 1-Year or 8,000 hours (whichever comes first.)

In North America, FLIR also offers On-Board Repair Service, a Warranty Service Program and Advance Warranty Replacement for some products. These programs and services, when available, are designed to help minimize the down - time of products that may require warranty repair.

For complete details on FLIR's industry-leading warranty please visit www.flir.com/maritime.

FLIR BELGIUM BVBA
LUXEMBURGSTRAAT 2
2321 MEER
BELGIUM
TEL. : +32 (0) 3665 5100

FLIR MARITIME
9 TOWNSEND WEST
NASHUA, NH 03063
USA
(603) 324-7900

FLIR SYSTEMS CO., LTD
RM 1613-16, 16/F, TOWER II,
GRAND CENTRAL PLAZA,
138 SHATIN RURAL
COMMITTEE ROAD,
SHATIN,
NEW TERRITORIES,
HONG KONG
TEL.: +852 2792 8955,
FAX.: +852 2792 8952



EQUIPMENT DESCRIBED HEREIN MAY REQUIRE US GOVERNMENT AUTHORIZATION FOR EXPORT PURPOSES.
DIVERSION CONTRARY TO US LAW IS PROHIBITED.
SPECIFICATIONS ARE SUBJECT TO CHANGE WITHOUT NOTICE. ©2015 FLIR SYSTEMS, INC. ALL RIGHTS RESERVED.
IMAGERY USED FOR ILLUSTRATION PURPOSES ONLY.



The World's Sixth Sense™